

NanoVNA-F V2

Portable Vector Network Analyzer

User Guide

Rev. 1.0

(for firmware V0.1.0)

Contents

1. Introduction	- 1 -
1.1. About NanoVNA-F V2.....	- 1 -
1.2. Features	- 1 -
1.3. Specifications	- 2 -
1.4. VNA basics.....	- 3 -
2. Appearance.....	- 4 -
3. User interface	- 5 -
3.1. Main screen	- 5 -
3.2. Menu screen.....	- 7 -
3.3. Keyboard screen	- 7 -
4. Menus	- 8 -
4.1. DISPLAY	- 8 -
4.2. MARKER.....	- 13 -
4.3. STIMULUS.....	- 16 -
4.4. CAL.....	- 17 -
4.5. RECALL/SAVE.....	- 21 -
4.6. SETTING.....	- 21 -
5. PC software	- 22 -
6. Command line.....	- 25 -
7. Firmware upgrade	- 26 -
8. Hardware architecture.....	- 27 -

1. Introduction

1.1. About NanoVNA-F V2

NanoVNA-F V2 is new generation 3GHz portable vector network analyzer. It is designed with 4.3-inch IPS LCD and aluminum alloy case. It has a built-in 5000mAh large capacity lithium battery and the standby time is up to 7 hours. It is full touching screen design and with 3 side buttons at the same time.

The design of NanoVNA-F V2 is based on edy555's NanoVNA and OwOcomm's SAA-V2, and the software and UI is deeply optimized. The operation method of NanoVNA-F V2 is compatible with NanoVNA-F. The measuring frequency range of NanoVNA-F V2 is extended to 3GHz, the dynamic range is larger, the measurement result is more accurate and the operation is more convenient.

1.2. Features

- 4.3-inch IPS LCD, ultra wide viewing angle;
- All aluminum alloy case;
- Dimension: 130mmx75mmx22mm, small and portable;
- SMA RF connectors, easy to connect DUTs;
- Built-in 3.7V 5000mAh lithium battery, standby time up to 7 hours;
- Full touching screen design, with 3 side buttons at the same time;
- Language: English and Chinese;
- Optimized UI design, make measurement convenient and efficiency;
- Screen brightness adjustable;
- Firmware upgrad via virtual U disk with USB Type-C cable;
- Equipped with high quality SMA calibration kit and RG405 cable;
- 5V/1A USB power output port;
- Charging via USB Type-C, maximum charging current reaches 2A;
- Compatible with nanovna-saver PC software;
- Support screenshot command;

1.3. Specifications

Parameter	Specification	Conditions
Frequency range	50kHz~3GHz	
RF output power	-10dBm	50kHz - 140MHz
	-9dBm	140MHz - 1GHz
	-12dBm	1GHz - 2GHz
	-14dBm	2GHz - 3GHz
Frequency accuracy	<±0.5ppm	
S21 dynamic range	70dB	50kHz - 1.5GHz
	60dB	1.5GHz - 3GHz
S11 dynamic range	50dB	50kHz - 1.5GHz
	40dB	1.5GHz - 3GHz
Sweep points	101	
Traces	4	
Markers	4	
Calibration storage	5	
Sweep time	1.5s	
Display	4.3-inch IPS LCD	resolution: 800*480
Touch screen	RTP	
Battery	3.7V 5000mAh	
Charging/Data port	USB Type-C	
Charging voltage	4.7V - 5.5V	
Power output	USB-A 5V/1A	
RF connector	SMA	
Dimensions	130*75*22mm	
Shell material	Aluminum alloy	
Operation temperature	0°C -45°C	

1.4. VNA basics

Vector Network Analyzer (VNA) is the most commonly used instrument in the field of RF and microwave. VNA measures the reflection and transmission behavior of a device under test (DUT) across a configured frequency range. VNA is usually used to measure antenna impedance, cable loss, filters, power splitters, couplers, duplexers, amplifiers, etc.

Note that the "network" mentioned here does not refer to a computer networks. When the name "network analyzer" was coined many years ago, there were no such things as computer networks. Back then, networks always referred to electrical networks. Today, when we refer to the things that network analyzers measure, we speak mostly about devices and components.

Network Analysis is NOT....



NanoVNA-F V2 is a dual-port portable vector network analyzer that can be used to measure the S11 parameters of a single-port network, or to measure the S11 and S21 parameters of a dual-port network. If you need to measure the S22 and S12 parameters of the dual-port network, you can achieve it by exchanging the measurement ports.

VNA must be calibrated before any measurements are performed. See section [4.4](#) for details.

2. Appearance

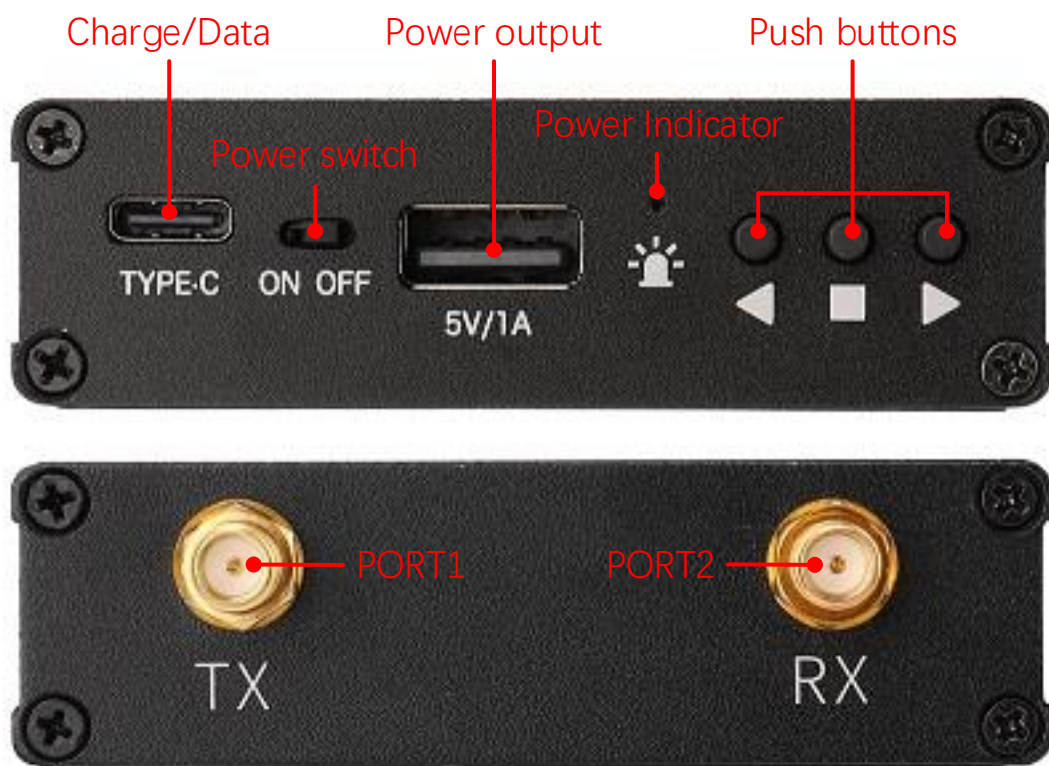

3. User interface

3.1. Main screen

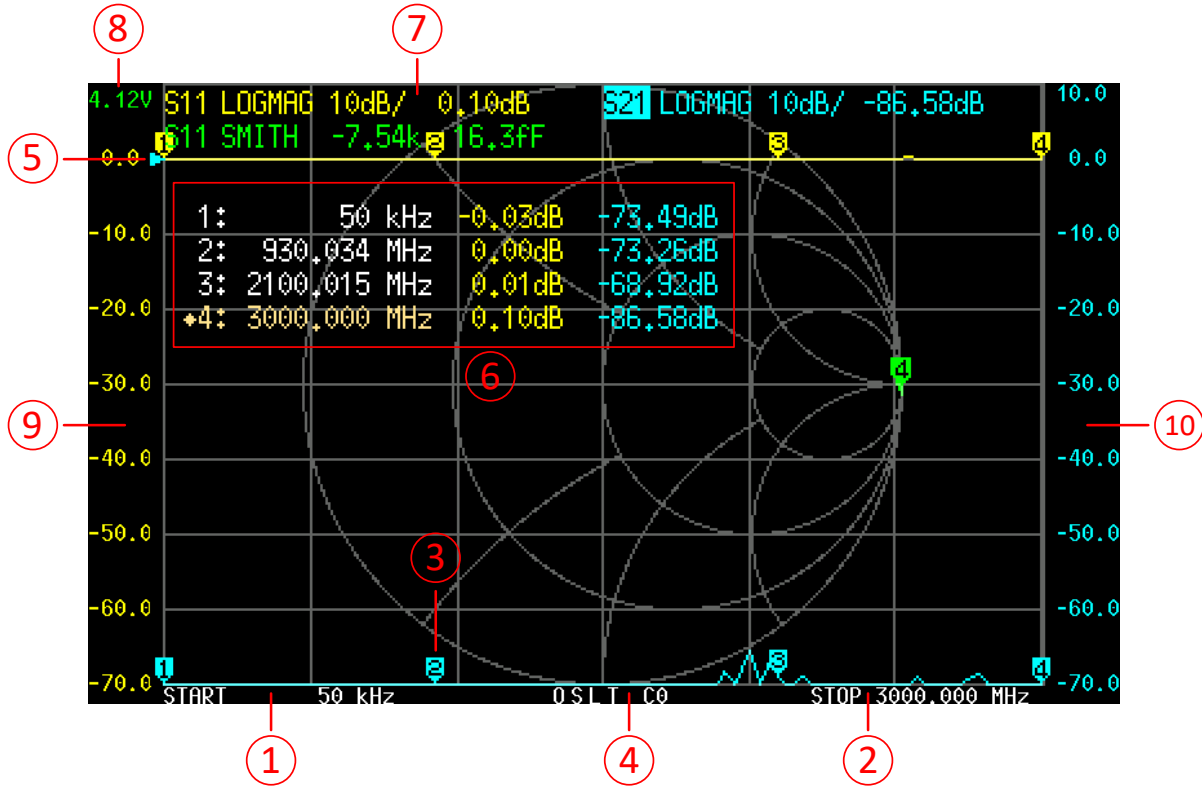

① START frequency

The START frequency is shown at this area.

② STOP frequency

The STOP frequency is shown at this area.

③ Marker

Up to 4 markers can be displayed at the same time.

The active marker can be moved to any of the measured points in the following 2 ways:

- Push the UP or DOWN buttons.
- Drag a marker on the touch panel (recommend to operate with a stylus).

④ Calibration status

O: Indicates OPEN calibration has been performed.

S: Indicates SHORT calibration has been performed.

L: Indicates LOAD calibration has been performed.

T: Indicates THROUGH calibration has been performed.

C: Indicates that the device has been performed a calibration.

*****: Indicates that the calibration data has not been stored and will be lost when power off.

c: Indicates that the calibration data is Interpolated.

Cn: Indicates that the corresponding calibration data is loaded.

⑤ Reference position

Indicates the reference position of the corresponding trace. You can change the position by:

[DISPLAY] → [SCALE] → [REFERENCE POSITION]

⑥ Marker Table

Up to 4 groups of marking information can be displayed at the same time, each group of marking information includes frequency and 2 other parameters.

The diamond mark in front of the marker table indicates which is the active marker.

You can open, select or close a marker by:

[MARKER] → [SELECT MARKER] → [MARKER n]

To quickly activate a marker, you can tap on the frequency value text of the corresponding row of the marker table (recommend to operate with a stylus).

It is possible to move the marker table up and down by:

[MARKER] → [SELECT MARKER] → [POSITION]

If you want to save the setting of marker table display position, you can do it by:

[RECALL/SAVE] → [SAVE] → [SAVE n]

⑦ Trace status

The status of each trace format and the value corresponding to the active marker are displayed.

For example, if the display is showing: **S21** **MAGLOG 10dB/ 0.03dB**, read it as follows:

The blue trace is current active

Channel: PORT2 (transmission)

Format: LOGMAG

Scale is 10dB

Current value is 0.03dB

⑧ Battery voltage

The voltage of the built-in lithium battery is shown here. If the battery voltage is lower than 3.3V, please charge the device.

⑨ Left scale axis

The left scale axis always shows the scale of trace 0.

Tap the area of left scale axis to quickly set the scale of trace 0.

⑩ Right scale axis

The right scale axis always shows the scale of current active trace.

Tap the area of right scale axis to quickly set the scale of current active trace.

3.2. Menu screen

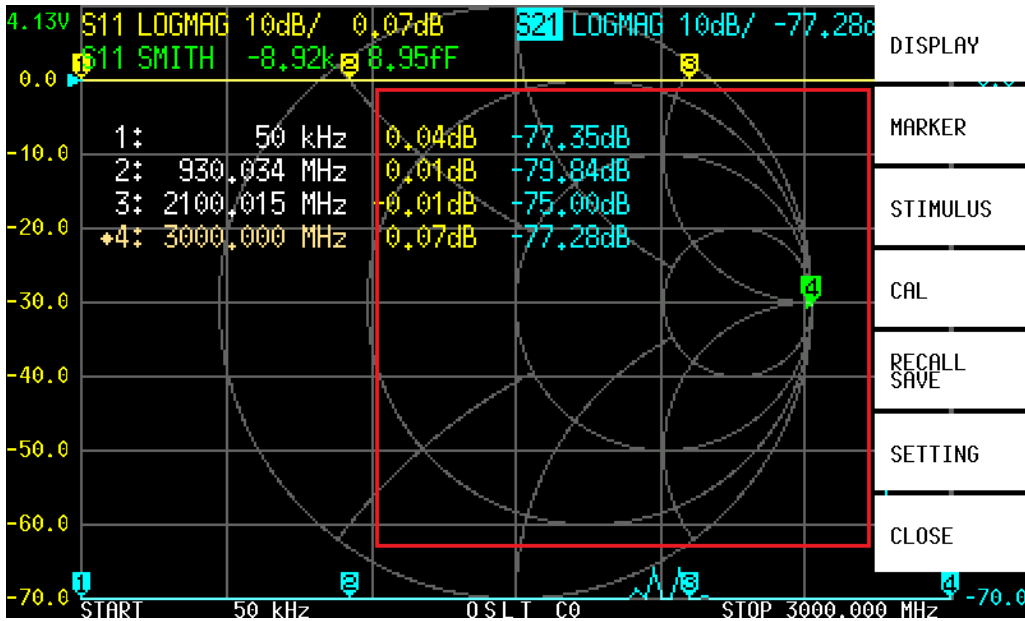

The menu can be opened by the following operations:

- Tap the right area of the screen (shown in the red frame above).
- Press the middle button.

3.3. Keyboard screen

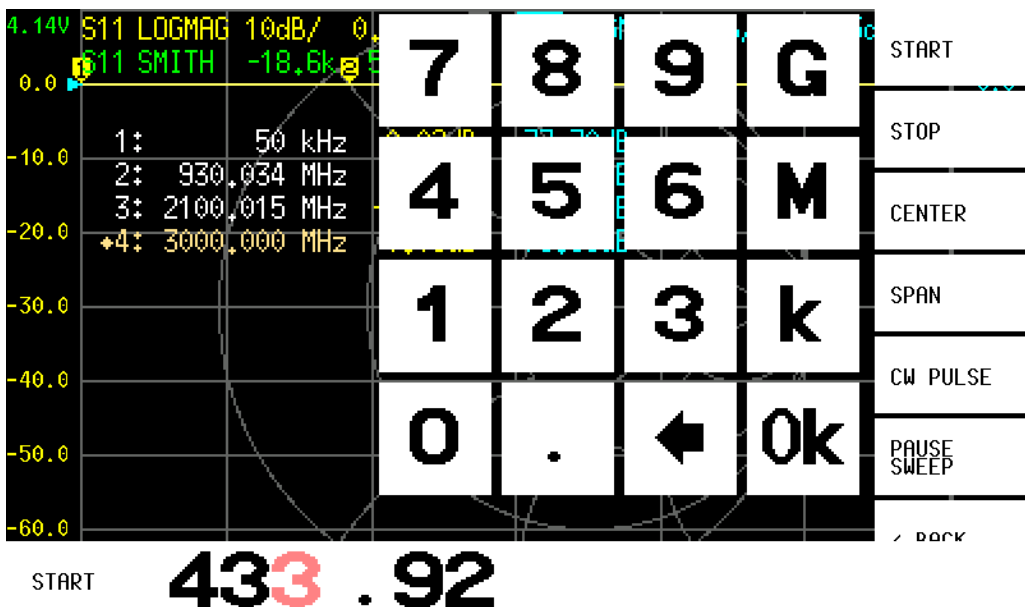

The virtual keyboard includes numeric keys, backspace key, unit key, ok key.

Backspace key is used to delete one character. When the input is empty or all deleted, tap the backspace key again to close the keyboard.

Unit key(**G**, **M**, **k**) multiplies the current input by the appropriate unit and terminates input immediately.

Ok key equals to x1, in case of ok, the entered value is set as it is.

E.g. : **100kHz** : input **100** + **k**, or input **100000** + **Ok**;
433.92MHz : input **433.92** + **M**;
2.4GHz : input **2.4** + **G**;

4. Menus

4.1. DISPLAY

[DSIPLAY] menu contains **[TRACE]** , **[FORMAT]** , **[SCALE]** , **[CHANNEL]** , **[TRANSFORM]** .

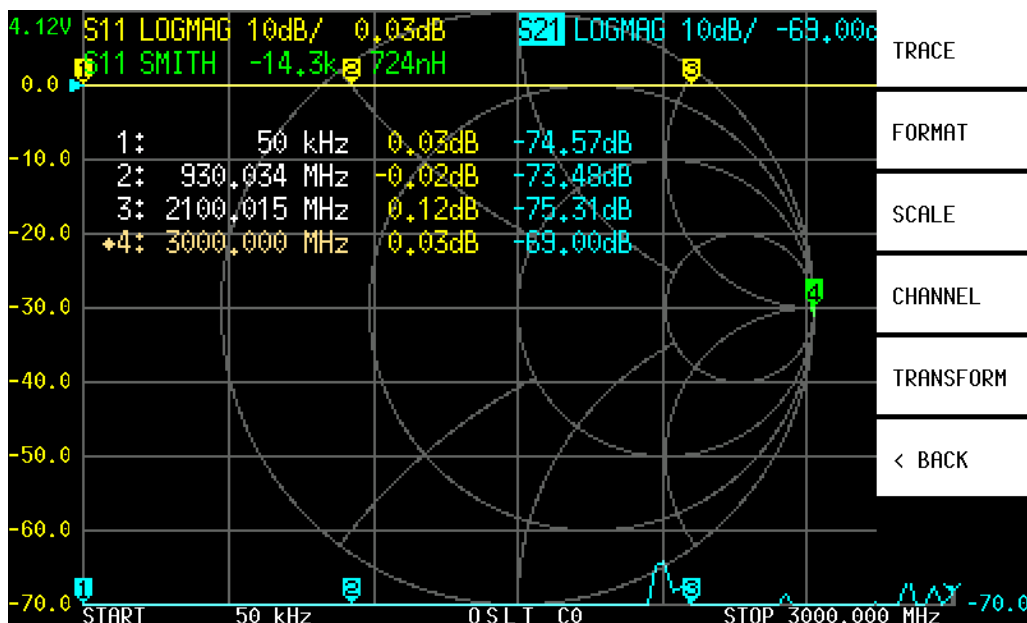

4.1.1 TRACE

[TRACE] submenu contains **[TRACE 0]** , **[TRACE 1]** , **[TRACE 2]** , **[TRACE 3]** .

If the background color of **[TRACE n]** is white, it means that **[TRACE n]** is closed, you can tap **[TRACE n]** (e.g. **[TRACE 3]**) to open this trace, at this time the background color of **[TRACE 3]** becomes purple, and the purple character trace status information will be displayed at the top of the main interface. The **S11** text at the beginning of the status information line is highlighted, indicating that the trace is the active trace.

Tap **[TRACE 3]** again to close the trace.

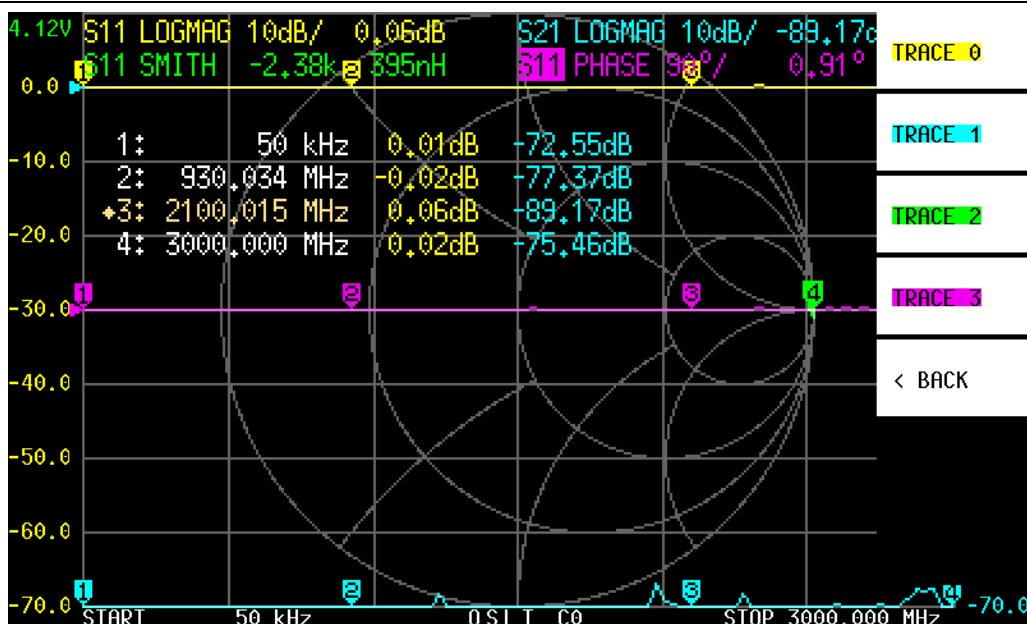

4.1.2 FORMAT

[FORMAT] submenu is used to set the format of traces. There are formats of **LOGMAG**, **PHASE**, **DELAY**, **SMITH**, **SWR**, **POLAR**, **LINEAR**.

LOGMAG: the ordinate corresponds to logarithmic amplitude and the abscissa corresponds to the frequency.

PHASE: the ordinate corresponds to the phase and the abscissa corresponds to the frequency.

DELAY: the ordinate corresponds to group delay and the abscissa corresponds to the frequency. Only meaningful for S21.

SMITH: show impedance with Smith chart. Only meaningful for S11.

SWR: the ordinate corresponds to VSWR and the abscissa corresponds to the frequency. Only meaningful for S11.

POLAR: show impedance in polar coordinates. Only meaningful for S11.

LINEAR: the ordinate corresponds to the linear amplitude, and the abscissa corresponds to the frequency.

There are 3 ways to activate a trace:

- (1) **[DISPLAY]** → **[TRACE]** → **[TRACE n]** .
- (2) Tap the format text of the trace in the Trace status area.
- (3) Tap any markers with the same color to the trace.

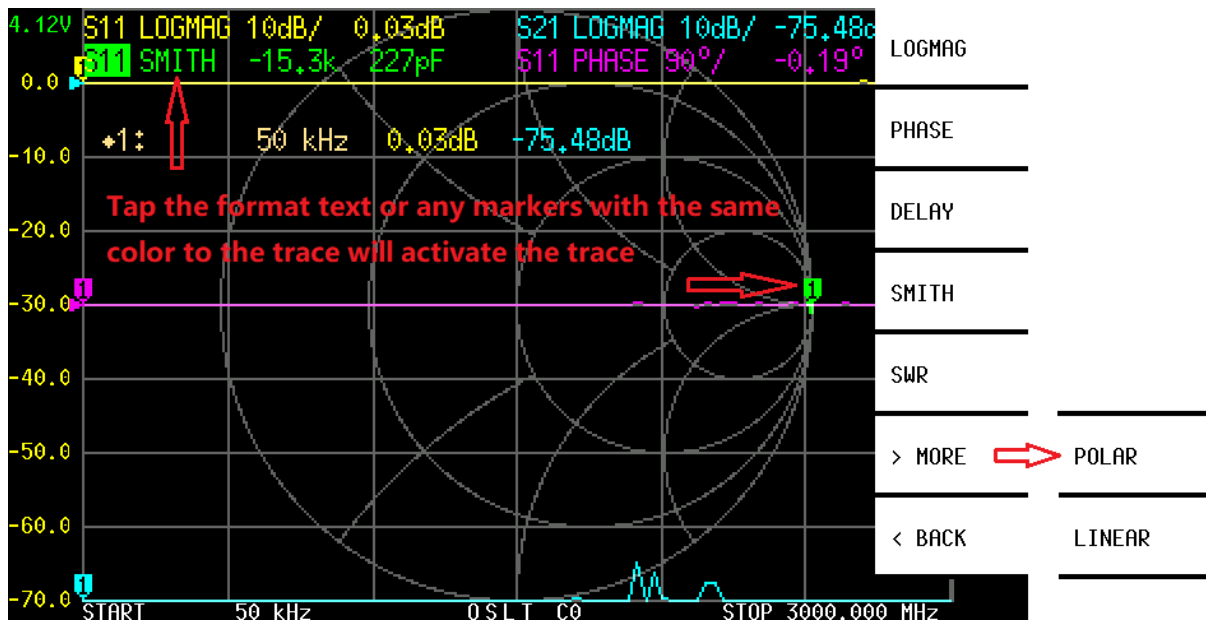

4.1.3 SCALE

[SCALE] submenu contains **[SCALE/DIV]** , **[REFERENCE POSITION]** , **[ELECTRICAL DELAY]** .

[SCALE/DIV]: For setting the scale of the ordinate (not applicable to **SMITH** and **POLAR** formats).

[REFERENCE POSITION]: For setting the reference position of the trace (not applicable to **SMITH** and **POLAR** formats). 0 corresponds to the horizontal axis at the bottom of the main interface, 8 corresponds to the horizontal axis at the top of the main interface, and can be set to an integer greater than or equal to 0.

For **LOGMAG** and **LINEAR** formats, the reference position defaults to 7.

For **PHASE** and **DELAY** formats, the reference position defaults to 4.

For **SWR** formats, the reference position defaults to 0.

[ELECTRICAL DELAY]: You can manually input a delay time to compensate for the delay introduced by the connector or cable, in nanoseconds (ns) or picoseconds (ps).

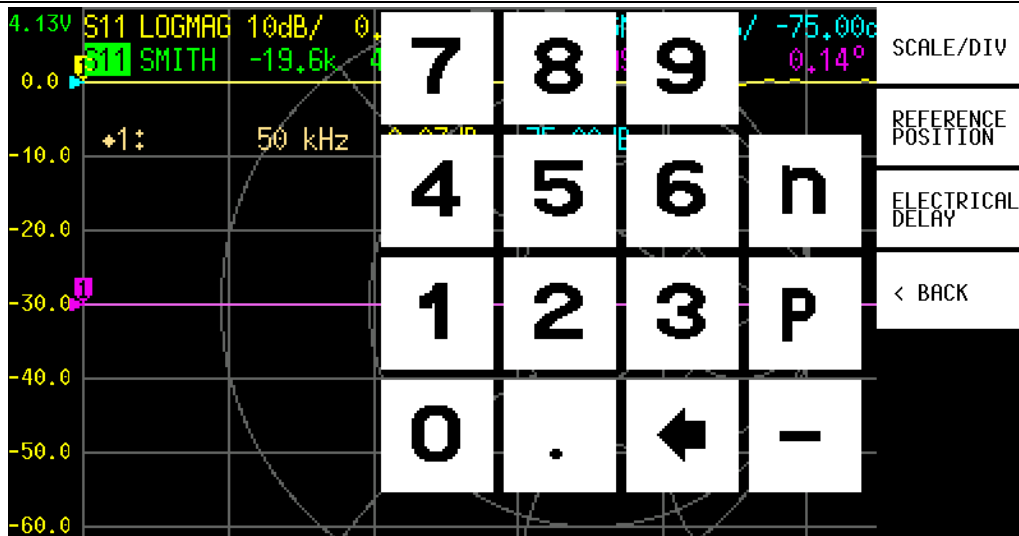

EDELAY

4.1.4 CHANNEL

[CHANNEL] submenu contains **[S11 REFLECT]** and **[S21 THROUGH]** . It is used to set the channel of the current active trace.

[S11 REFLECT] corresponds to PORT1, **[S21 THROUGH]** corresponds to PORT 2.

4.1.5 TRANSFORM

NanoVNA-F V2 can simulate time domain reflectometry by transforming frequency domain data. **TRANSFORM** is only meaningful for S11.

[TRANSFORM] submenu contains **[TRANSFORM ON]**, **[LOW PASS IMPULSE]** , **[LOW PASS STEP]** , **[BANDPASS]** , **[WINDOW]** , **[VELOCITY FACTOR]** .

Tap **[TRANSFORM ON]** to convert measured data to the time domain.

If **[TRANSFORM ON]** is enabled (Inverted white text on black background), the measurement data is immediately converted to the time domain and displayed. The relationship between the time domain and the frequency domain is as follows.

- Increasing the maximum frequency increases the time resolution.
- The shorter the measurement frequency interval (e.g. the lower the maximum frequency), the longer the maximum time length.

For this reason, the maximum time length and time resolution are in a trade-off relationship. In other words, the time length is the distance.

- If you want to increase the maximum measurement distance, you need to lower the frequency spacing (frequency span / sweep points).
- If you want to measure the distance accurately, you need to increase the frequency span.

Connect a cable to PORT1, keep the other end of the cable open or short, move the marker to the peak of S11 trace, and the estimated cable length will be displayed on the screen.

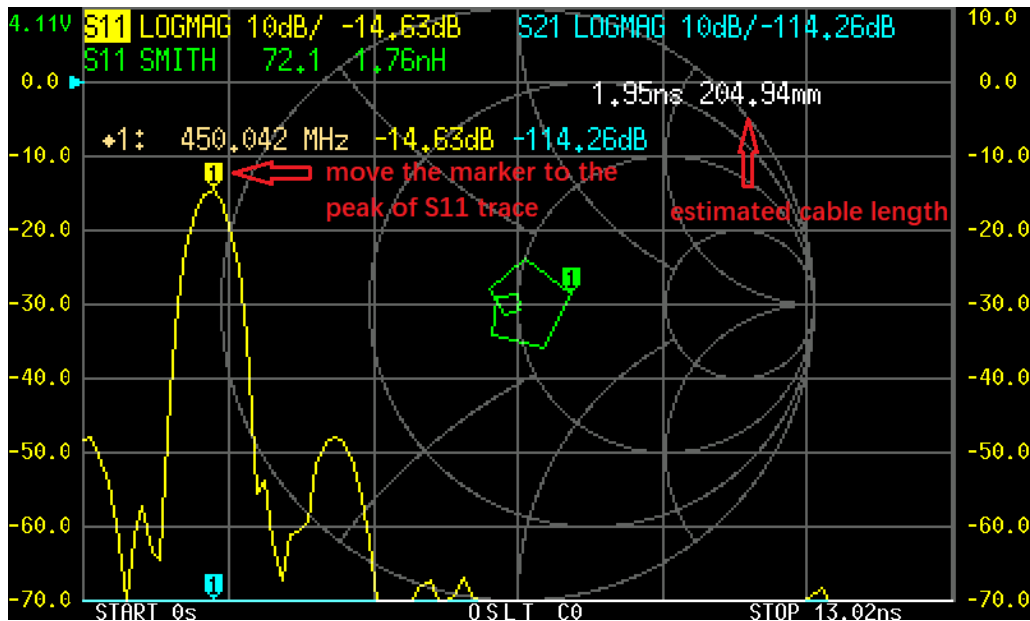

There are 3 kinds of digital processing mode available: **[LOW PASS IMPULSE]**, **[LOW PASS STEP]**, **[BANDPASS]**, and default setting is **[BANDPASS]**.

The range that can be measured is a finite number, and there is a minimum frequency and a maximum frequency. A window can be used to smooth out this discontinuous measurement data and reduce ringing.

There are three levels of windowing: **[MINIMUM]**, **[NORMAL]**, **[MAXIMUM]**, and default setting is **[NORMAL]**.

Velocity factor is defined as the ratio of the transmission speed of electromagnetic waves in the transmission line to the transmission speed of electromagnetic waves in vacuum.

Tap **[VELOCITY FACTOR]** to set the velocity factor. E.g. the typical velocity factor of RG405 cable is 0.7, you can input 70 via the virtual keyboard and tap Ok, then the velocity factor will be set to 70%.

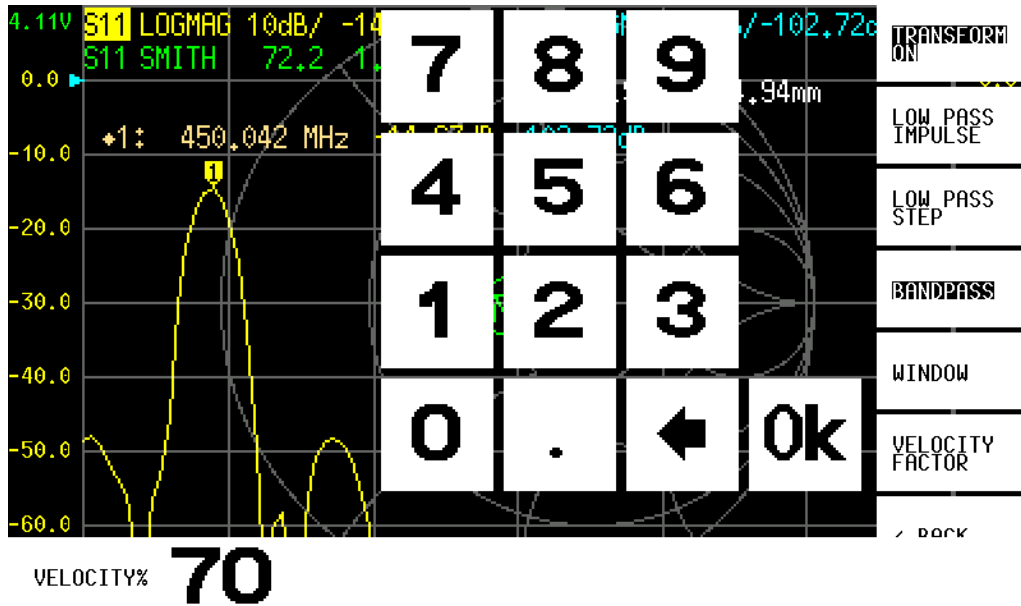

NOTE: Use a lower frequency to measure a longer length and a higher frequency to measure a shorter length and adjust accordingly for accurate results.

4.2. MARKER

[MARKER] menu contains **[SELECT MARKER]** , **[SEARCH]** , **[OPERATION]** , **[SMITHVALUE]** .

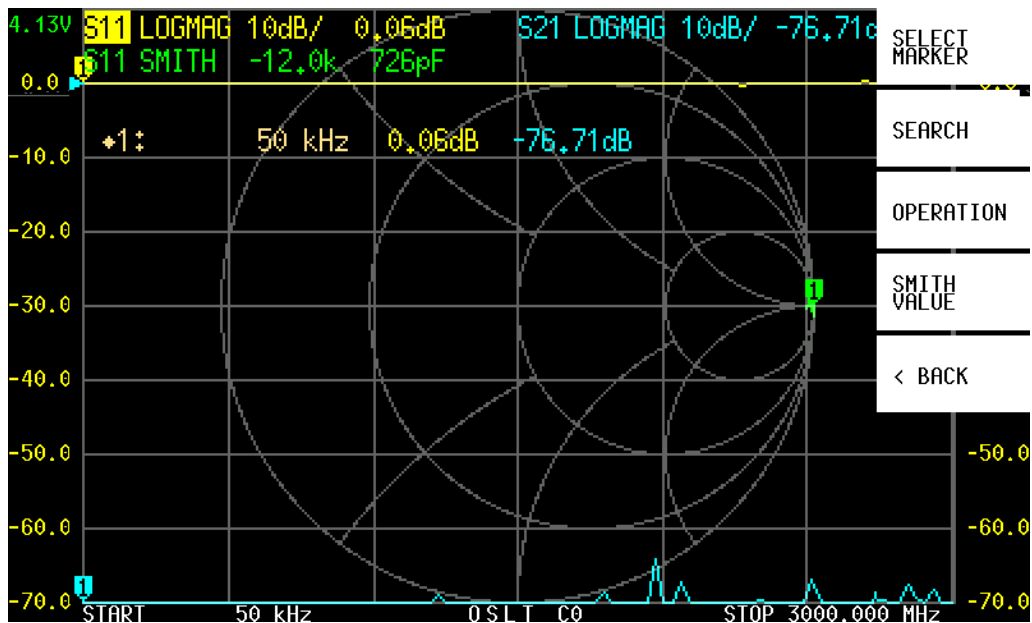

4.2.1 SELECT MARKER

[SELECT MARKER] submenu contains **[MARKER 1]** , **[MARKER 2]** , **[MARKER 3]** , **[MARKER 4]** , **[ALL OFF]** , **[POSITION]** .

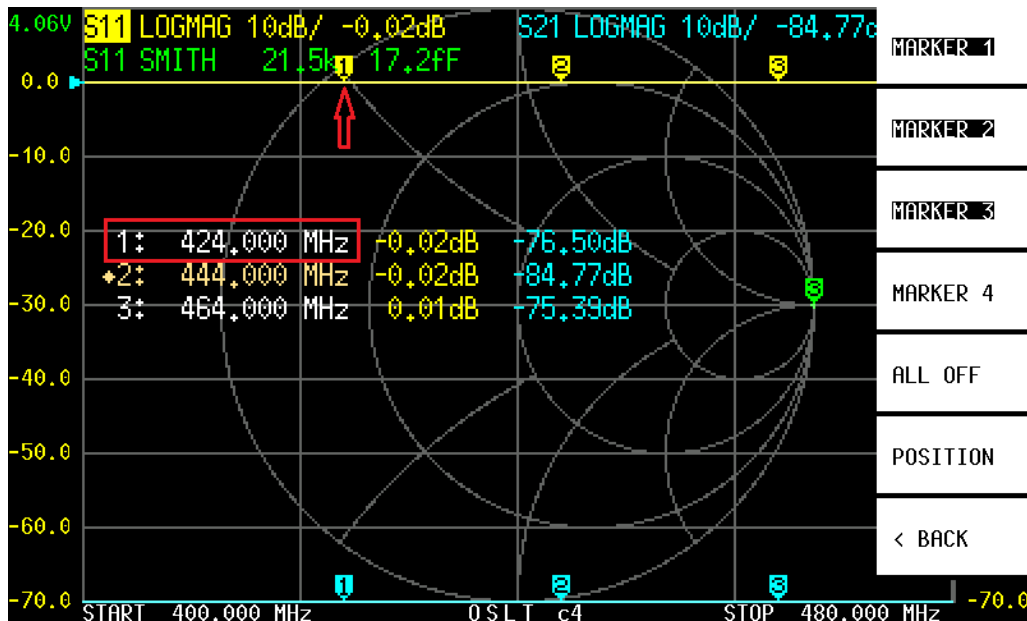

[MARKER n] It is used to select, turn on or off the corresponding marker. If a marker is in the off state (take **[MARKER 2]** as an example), the background color of the menu item is white before tapping. Tap **[MARKER 2]** will turn on marker2, and a diamond mark will appear in front of the marker number of marker table, indicating that marker2 is the active marker. Tap **[MARKER 2]** again will turn off marker2.

Tap the menu item corresponding to a marker that has been turned on will activate the marker. For example, after tapping **[MARKER 1]**, the diamond mark in the marker table will move to the first row, indicating that marker1 is the active marker. Tap **[MARKER 1]** again will turn off marker1.

The marker can be moved with the buttons only when it is active.

There are two ways to quickly activate a marker:

- (1) Tap on the marker directly, as shown by the red arrow in the figure above (recommend to operate with a stylus).
- (2) Tap on the frequency value text corresponding to the marker in the marker table, as shown in the red box in the above (recommend to operate with a stylus).

[ALL OFF] It is used to turn off all markers at once.

Used to adjust the display position of the marker table. The marker table can be moved up and down to avoid occluding traces and marker points.

[POSITION] It is used to adjust the position of the marker table on screen. The marker table can be moved up and down to avoid occluding traces and markers.

4.2.2 SEARCH

[SEARCH] submenu contains **[MAXIMUM]**, **[MINIMUM]**, **[SEARCH < LEFT]**, **[SEARCH > RIGHT]**, **[TRACKING]**, and all the menu items act on the active markers.

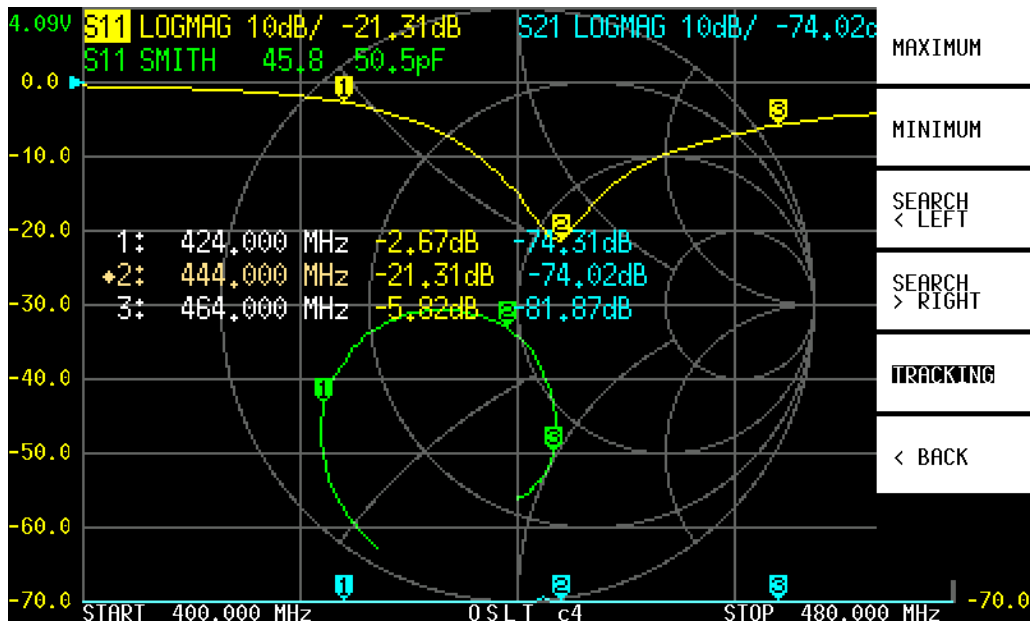

[TRACKING] It is used to automatically track the maximum or minimum value on the trace. As shown in the figure above, if you want to use marker2 to automatically track the minimum value of the S11 LOGMAG trace, firstly you should activate marker2, and then tap **[MINIMUM]** , and finally tap **[TRACKING]** . After doing that, marker2 will automatically move to the valley point of the S11 LOGMAG trace after each sweep.

4.2.3 OPERATE

[OPERATE] submenu contains **[>START]** , **[>STOP]** , **[>CENTER]** , **[>SPAN]** .

[>START] : Set the frequency of the current active marker as the start frequency.

[>STOP] : Set the frequency of the current active marker as the stop frequency.

[>CENTER] : Set the frequency of the current active marker as the center frequency.

[>SPAN] : Set the frequency range between the current active marker and the next marker as the span. If there are no other markers behind the current active marker, the span will be set to zero.

4.2.4 SMITH VALUE

[SMITH VALUE] submenu contains **[Re + Im]** and **[R+L/C]** . It is used to set the display format of impedance value, the default selection is **[R+L/C]** .

[Re + Im] : Impedance value is displayed in the format of Re+Im, Re is the real part of impedance, and Im is the imaginary part of impedance.

[R+L/C] : Impedance value is displayed in the format of R+L/C, R is the resistance value, L/C is the equivalent inductance or capacitance value.

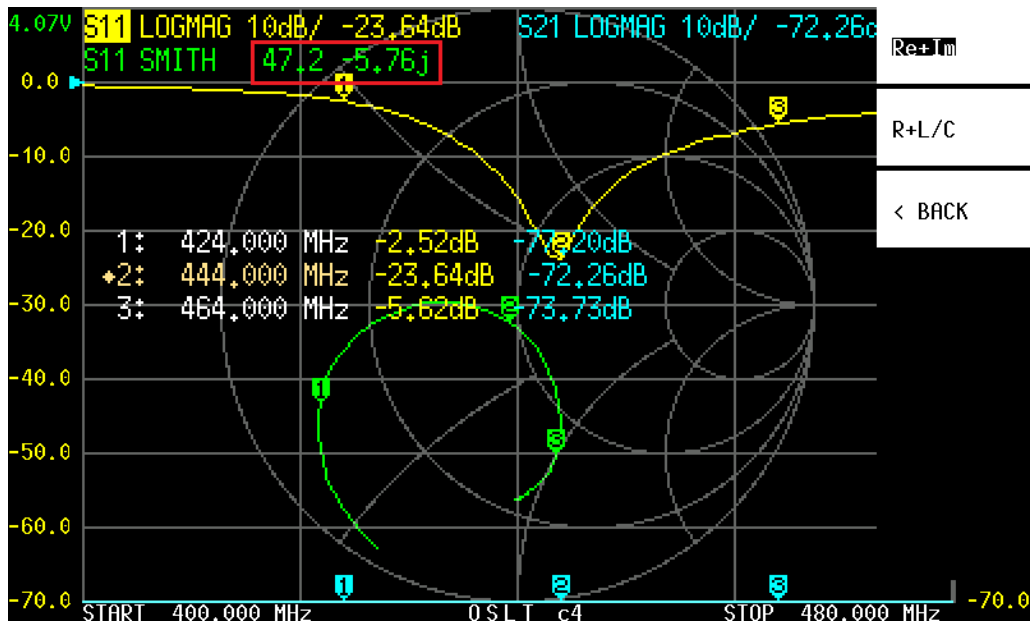

4.3. STIMULUS

[STIMULUS] menu contains [START] , [STOP] , [CENTER] , [SPAN] , [CW PULSE] , [PAUSE SWEEP] .

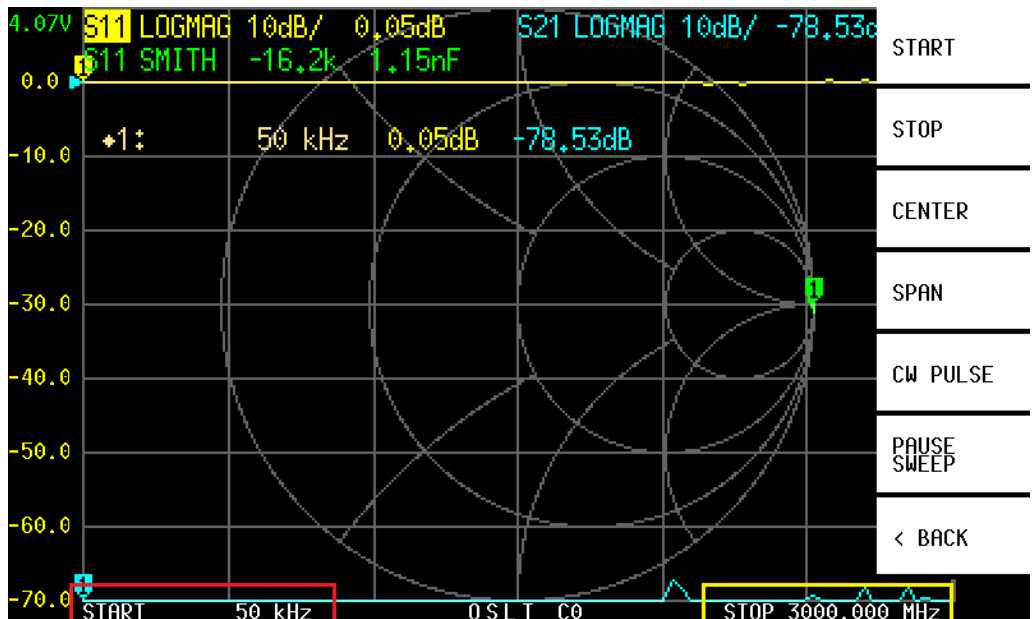

4.3.1 START

Tap on [START] to set the start frequency.
 You can also tap on the red box area in the above figure to quickly set the start frequency.

4.3.2 STOP

Tap on [STOP] to set the stop frequency.
 You can also tap on the yellow box area in the above figure to quickly set the stop frequency.

4.3.3 CENTER

Tap on **[CENTER]** to set the center frequency.

You can also tap on the red box area in the above figure to quickly set the center frequency.

4.3.4 SPAN

Tap on **[SPAN]** to set the frequency span.

You can also tap on the yellow box area in the above figure to quickly set the frequency span.

4.3.5 CW PULSE

Tap on **[CW PULSE]** to set the CW pulse frequency.

You can also tap on the red box area in the above figure to quickly set the CW pulse frequency.

4.3.6 PAUSE SWEEP

Tap on **[PAUSE SWEEP]** to pause sweep, tap again to resume sweep.

4.4. CAL

[CAL] menu contains **[CALIBRATE]** , **[RESET]** , **[CORRECTION]** .

4.4.1 CORRECTION

[CORRECTION] is turned on by default, indicating that the calibration data has been applied. Tap on **[CORRECTION]** to turn it off. After doing that, the calibration status **Cn** at the bottom of the main screen will disappear, indicating that the measurement result is not eliminated ;

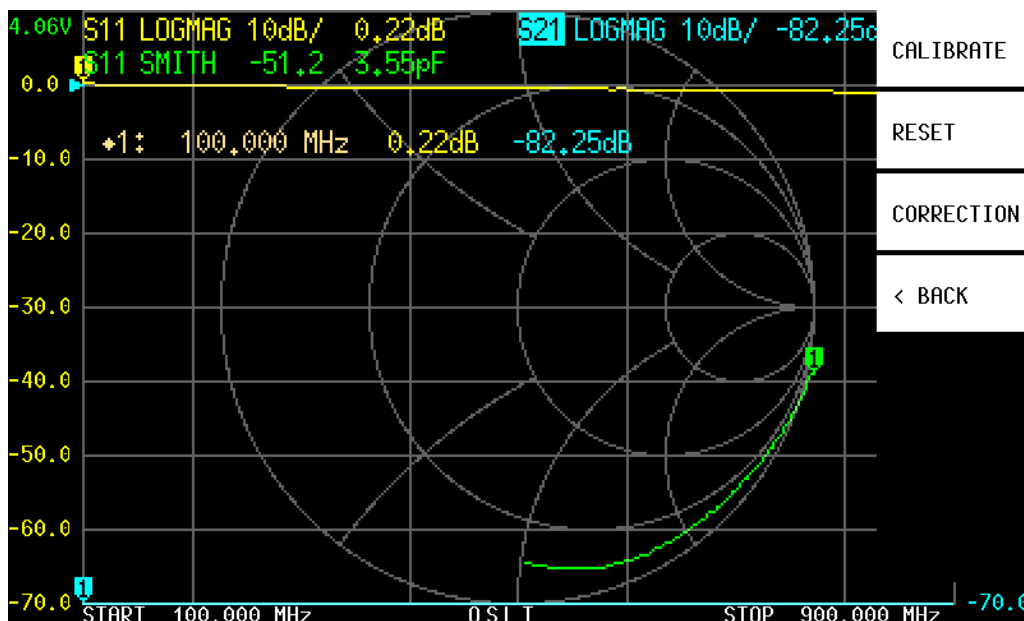

4.4.2 RESET

Tap on **[RESET]** to clear the calibration data in the memory. After doing that, the calibration status **OSLT Cn** at the bottom of the main screen will disappear, but the calibration data stored in the internal FLASH will not be cleared. You can call back the calibration data to the memory by

[RECALL/SAVE] → **[RECALL]** → **[RECALL n]**

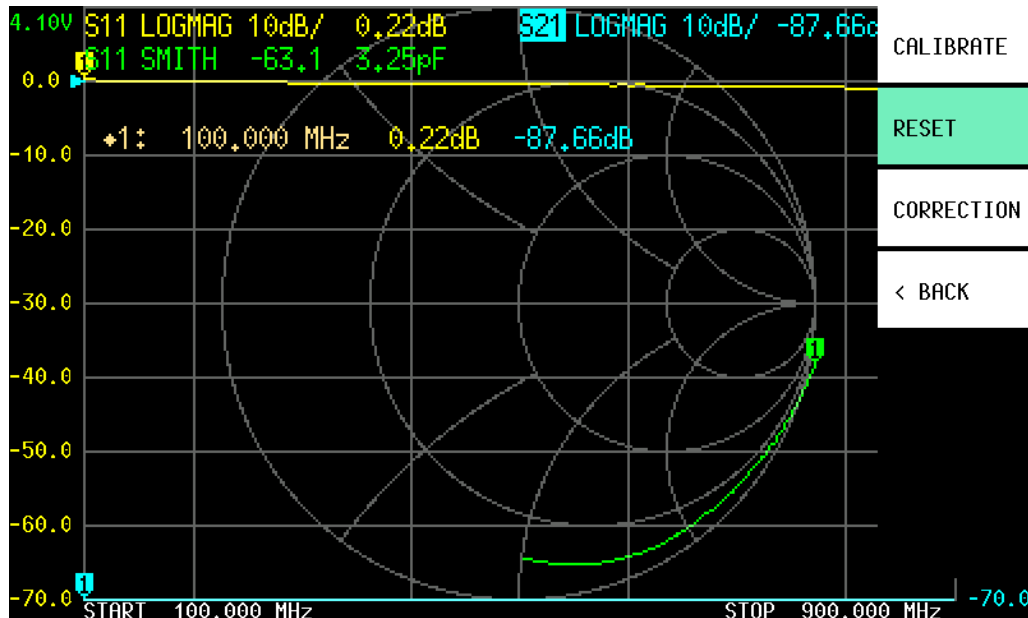

4.4.3 CALIBRATE

Tap on **[CALIBRATE]** to perform calibration. The following accessories need to be prepared before calibration:

- (1) SMA OPEN kit;
- (2) SMA SHORT kit;
- (3) SMA LOAD kit;
- (4) SMA-JJ RG405 cable;
- (5) SMA straight through adapter (optional);

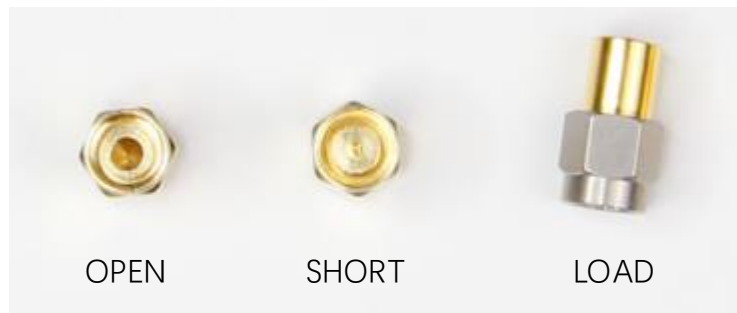

You need to set an appropriate frequency range at first, see section [4.3](#) for detail.

Tap on **[CALIBRATE]** to enter the calibration interface, and perform the calibration according to the following steps:

STEP ①

Connect the OPEN kit to the PORT1 or the end of the cable connected to the PORT1, as shown in the figure below:

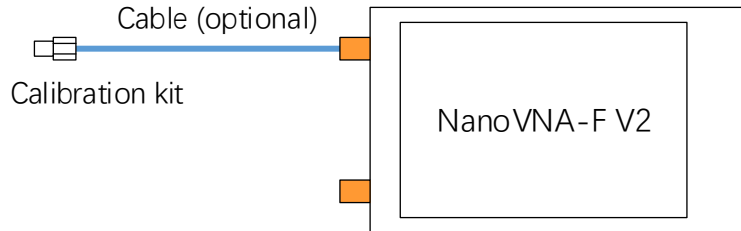

Tap on **[OPEN]**, the device emits a beep, and the menu turns gray and is inoperable. Wait for 2-3 seconds, the device emits a beep again, **[OPEN]** is highlighted, and the letter "O" appears at the bottom of the screen, indicating that open calibration has been completed.

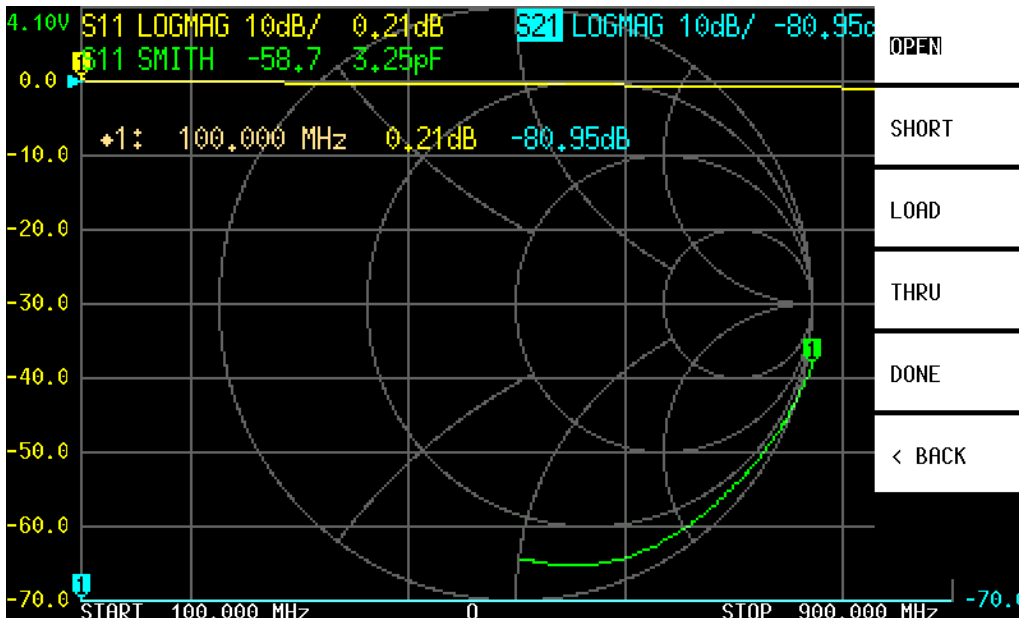

NOTE: usually we need to connect the DUT to VNA with cables, at this time, the cable becomes a part of the measurement system, and the end of the cable should be treated as the VNA port during calibration.

STEP ②

Connect the SHORT kit to the PORT1 or the end of the cable connected to the PORT1, tap on **[SHORT]** to complete the short calibration.

STEP ③

Connect the LOAD kit to the PORT1 or the end of the cable connected to the PORT1, tap on **[LOAD]** to complete the load calibration.

STEP ④

Connect PORT1 and PORT2 with cable and adaptor (optional), as shown in the figure below, then tap on **[THROUGH]** to complete the through calibration.

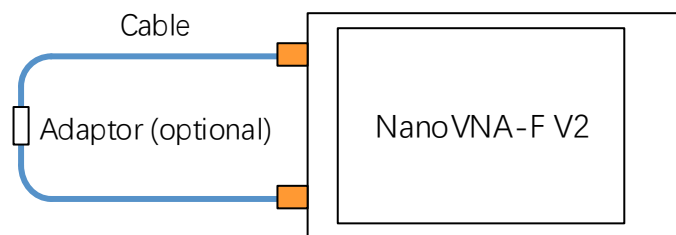
STEP ⑤

Tap on **[DONE]**, OSLT C* will appear at the bottom of the screen, indicating that the calibration data has been generated but not yet saved. The save menu will appear on the right side of the screen at the same time, tap on **[SAVE n]** to save the calibration data.

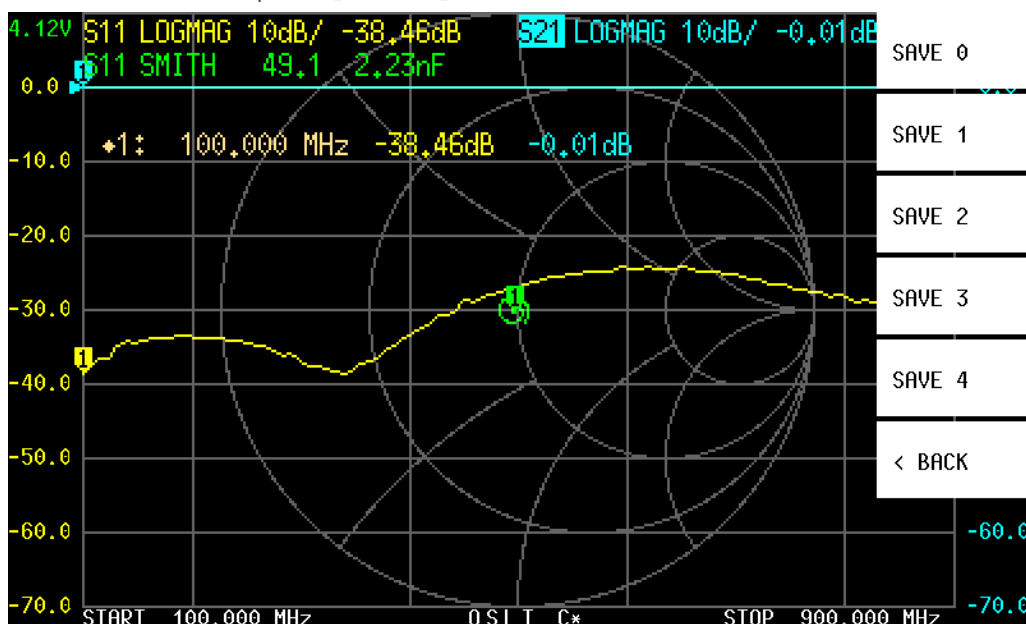

When properly calibrated, the VNA device should have the following characteristics:

- (1) When PORT1 is open, the S11 Smith trace converges on the far right side of the Smith circle, the S11 LOGMAG trace is near 0dB, for S21 LOGMAG trace, the lower the better.
- (2) When PORT1 is short-circuited, the S11 Smith trace converges on the leftmost side of the Smith circle, the S11 LOGMAG trace is near 0dB, for S21 LOGMAG trace, the lower the better.
- (3) When PORT1 is connected to a 50 ohm load, the S11 Smith traces converge at the center of the Smith circle. The lower the S11 and S21 LOGMAG trace, the better.
- (4) When PORT1 and PORT2 connected by a cable, the S11 Smith trace is near the center of the Smith circle, and the S21 LOGMAG trace is near 0dB. For S11 LOGMAG trace, the lower the better.

4.5. RECALL/SAVE

[RECALL/SAVE] menu contains **[RECALL]** and **[SAVE]** .

4.5.1 RECALL

Tap on **[RECALL]** to recall calibration data and settings.

4.5.2 SAVE

Tap on **[RECALL]** to save calibration data and current settings.

4.6. SETTING

[SETTING] menu contains **[TOUCHCAL]** , **[TOUCH TEST]** , **[LANGSET]** , **[ABOUT]** , **[BRIGHTNESS]** .

4.6.1 TOUCHCAL

If the touch screen is not accurate, you can enter **[TOUCHCAL]** to calibrate the touch screen. Tap on **[TOUCHCAL]** , a cross will appear in the upper left corner of the screen, tap the center of the cross (recommended to operate with a stylus), then a second cross appears in the lower right corner of the screen, tap the center of the cross again to complete the touch screen calibration.

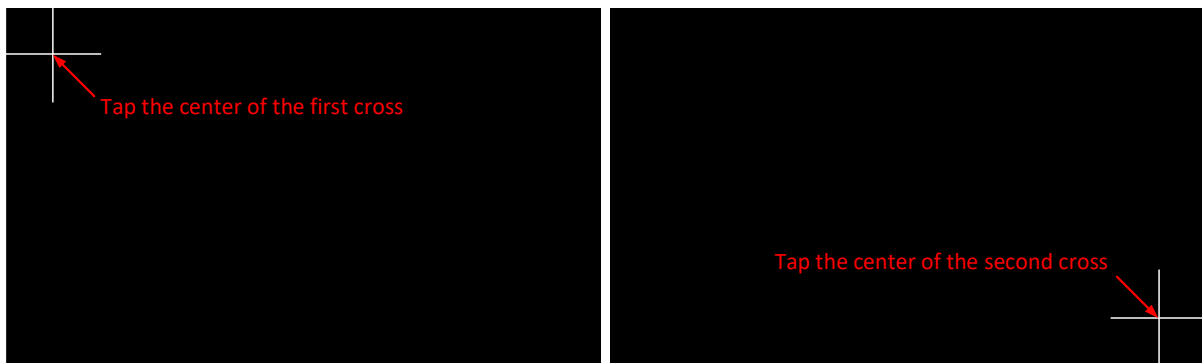

NOTE: If it is not able to enter **[TOUCHCAL]** menu item through touch screen, you should do it with the push buttons.

4.6.2 TOUCH TEST

It is used to verify the accuracy of the touch screen calibration result.

4.6.3 LANGSET

NanoVNA-F V2 supports English and Chinese.

4.6.4 ABOUT

You can check the hardware version, firmware version, serial number and supporting information, etc.

Each NanoVNA-F V2 device has a unique serial number, SYSJOINT provides after-sales service to customers based on this serial number.

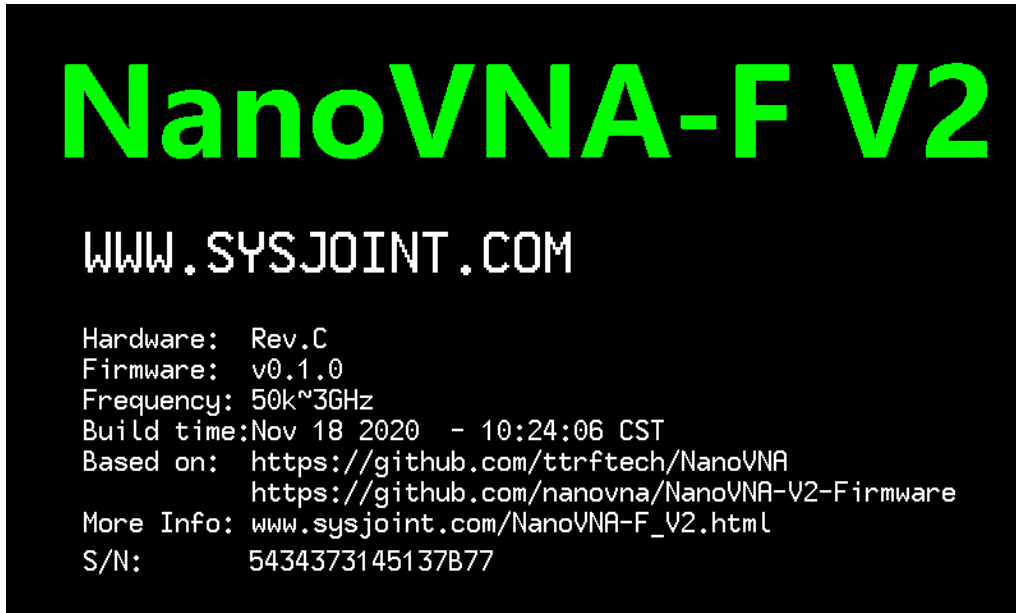

4.6.5 BRIGHTNESS

The screen backlight brightness is adjustable in five levels: 100%、80%、60%、40%、20%。

5. PC software

PC software download: http://www.sysjoint.com/file/NanoVNA_Saver_0.2.2--by%20SYSJOINT.rar

For Win10 system, you do not need to install the driver.

For Win8 and earlier versions of the Windows system, you need to install the driver: <https://www.st.com/en/development-tools/stsw-stm32102.html>

PC software provided by SYSJOINT only supports Windows system, Linux or MacOS version of the PC software is available from: <https://github.com/NanoVNA-Saver/nanovna-saver/releases>

Connect NanoVNA-F V2 to your PC with the USB Type-C cable, as shown in the figure below:

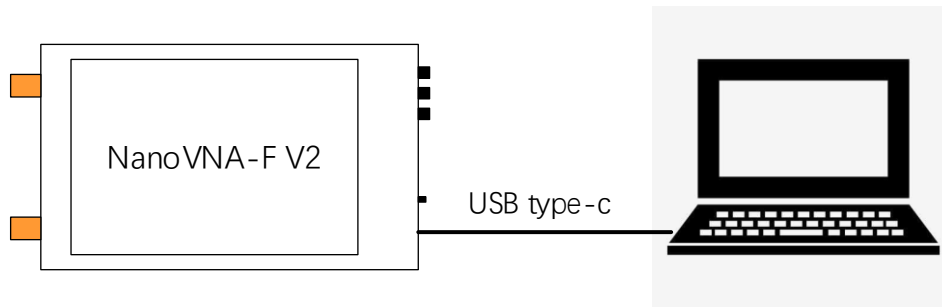

Double click “nanovna-saver.exe” to run the PC software, and select the correct COM port. If there is no COM port detected, please click **[Rescan]** .

After selecting the correct COM port, click **[connect to NanoVNA]** to connect the device to PC.

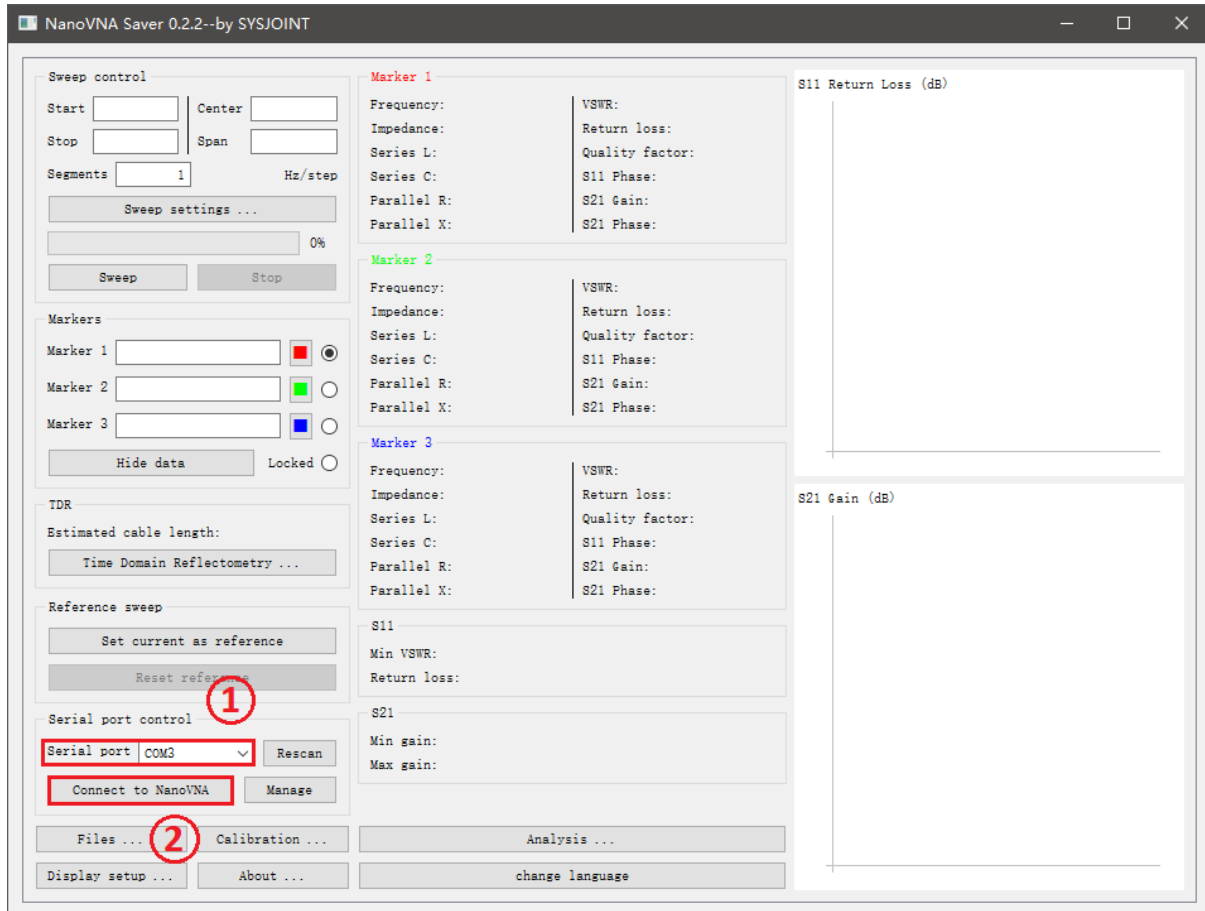

Through the PC software, you can set the start and stop frequency, get the measurement results, set the marker, take a screenshot, etc.

It is possible to get the device screen dump through the PC software:

- (1) Click **[Manage]** to open ‘Device setting’ dialog box.
- (2) Click **[Screenshot]** and wait for about 5 seconds.
- (3) Move the mouse to the image area, right-click and select “Save Image” to save the screenshot image to local disk.

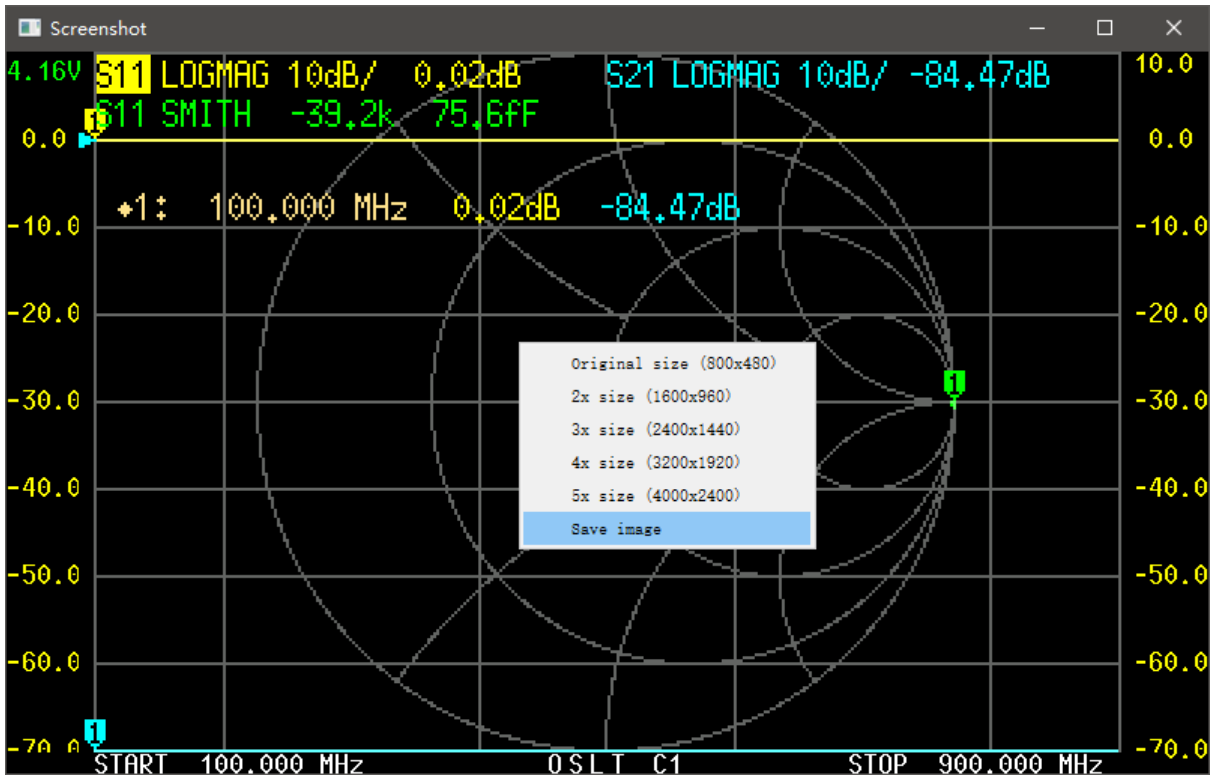
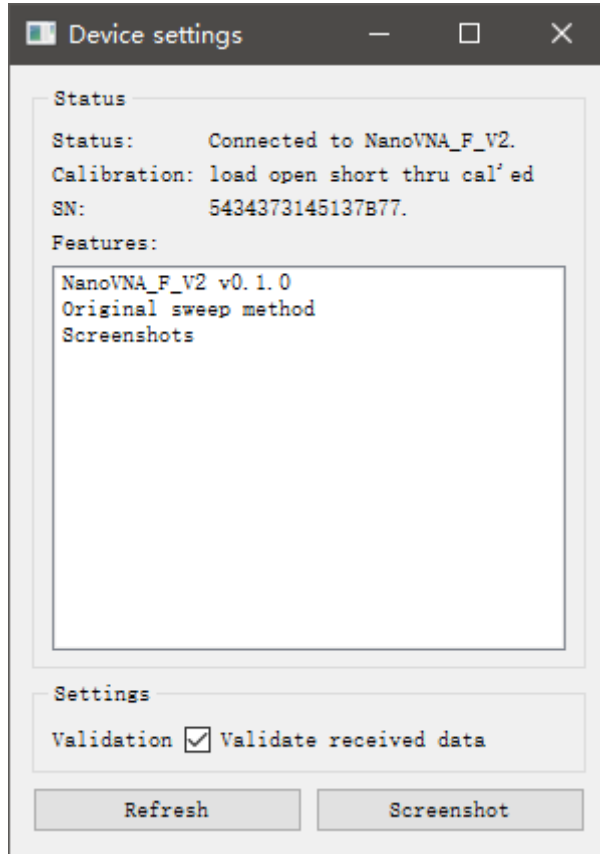

6. Command line

NanoVNA-F V2 supports command line, you can interact with the device through serial tools (such as PuTTY).

It is also possible to design a customized PC software according to the commands.

The serial port baud rate of NanoVNA-F V2 is adaptive, usually we choose a baud rate of 115200, as shown in the figure below:

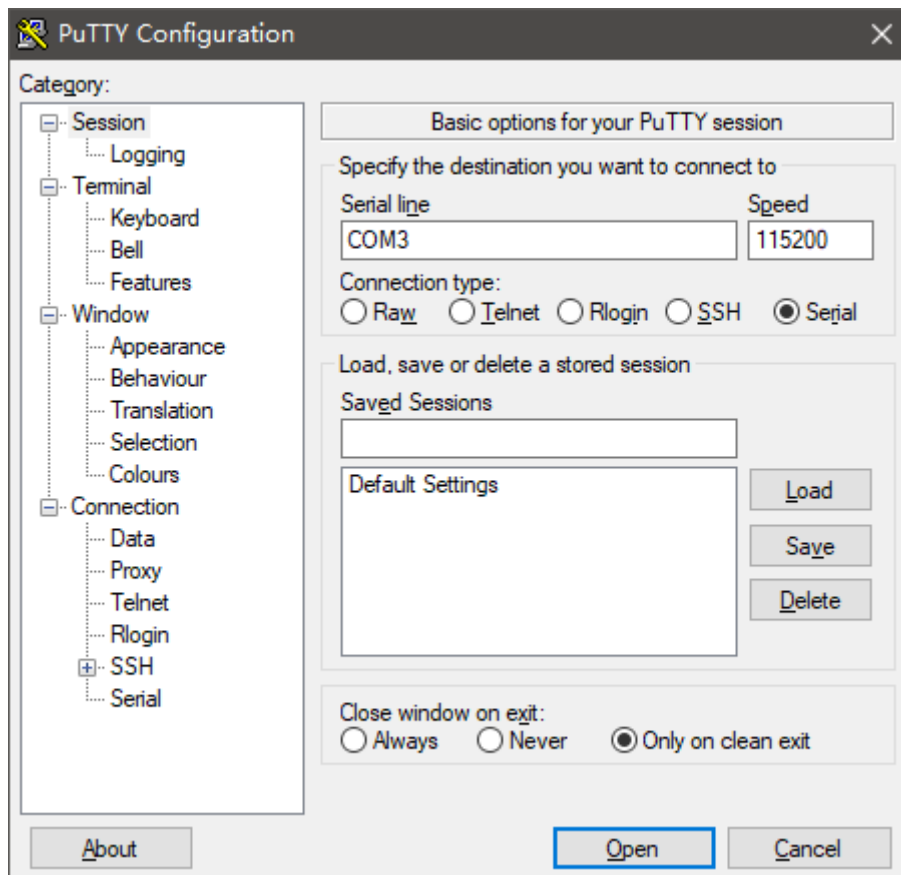

When the device is connected to a COM port of PC, you can enter 'help' to view all supported commands, as shown in the figure below:

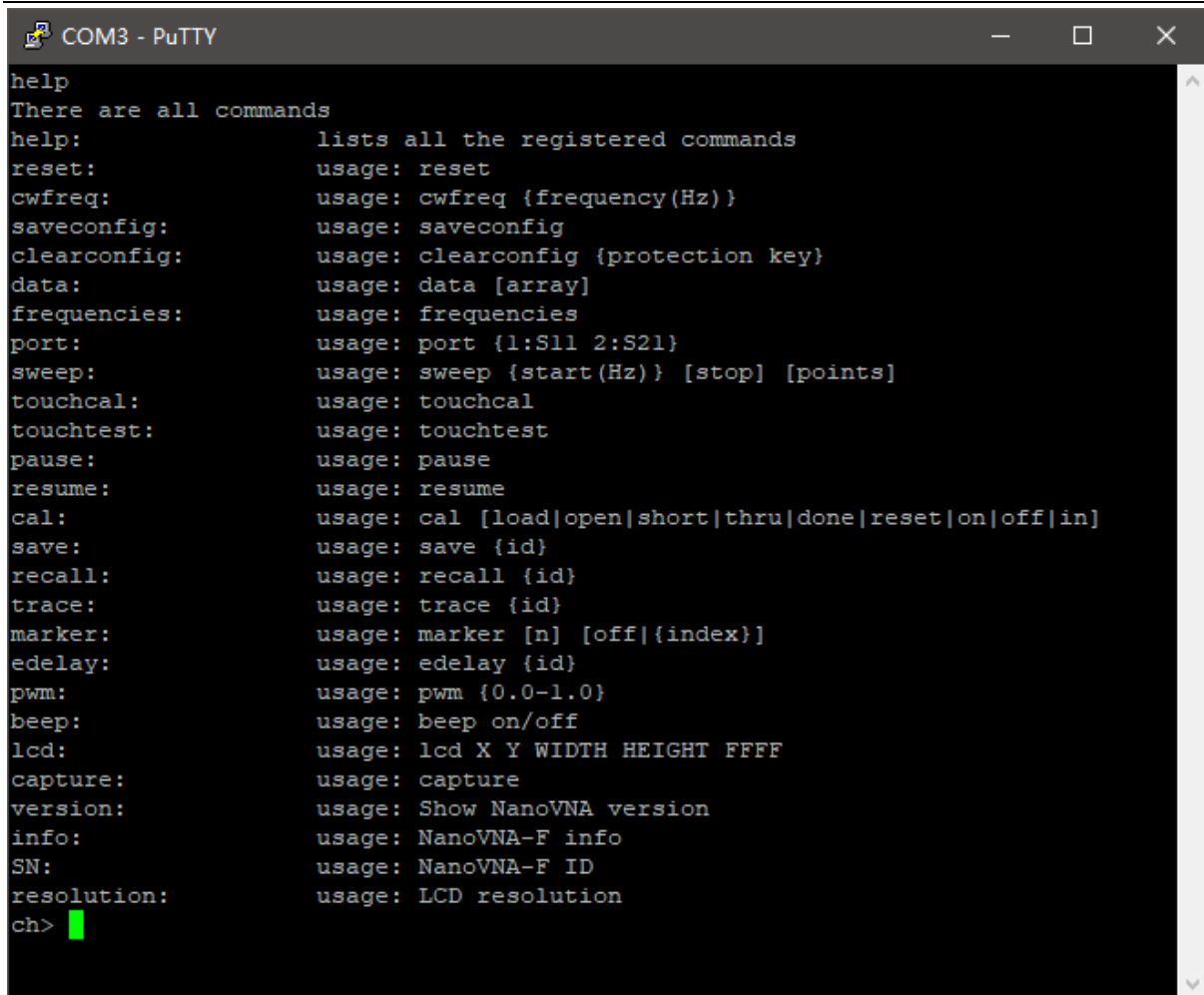

```
COM3 - PuTTY
help
There are all commands
help:          lists all the registered commands
reset:         usage: reset
cwfreq:        usage: cwfreq {frequency(Hz)}
saveconfig:    usage: saveconfig
clearconfig:   usage: clearconfig {protection key}
data:          usage: data [array]
frequencies:   usage: frequencies
port:          usage: port {1:S11 2:S21}
sweep:         usage: sweep {start(Hz)} [stop] [points]
touchcal:      usage: touchcal
touchtest:     usage: touchtest
pause:         usage: pause
resume:        usage: resume
cal:           usage: cal [load|open|short|thru|done|reset|on|off|in]
save:          usage: save {id}
recall:        usage: recall {id}
trace:         usage: trace {id}
marker:        usage: marker [n] [off|{index}]
edelay:        usage: edelay {id}
pwm:           usage: pwm {0.0-1.0}
beep:          usage: beep on/off
lcd:           usage: lcd X Y WIDTH HEIGHT FFFF
capture:       usage: capture
version:       usage: Show NanoVNA version
info:          usage: NanoVNA-F info
SN:            usage: NanoVNA-F ID
resolution:    usage: LCD resolution
ch>
```

7. Firmware upgrade

The firmware of NanoVNA-F V2 can be upgraded through virtual U-disk without a programmer (such as J-LINK). The upgrade can be done with the USB Type-C cable.

Connect NanoVNA-F V2 to PC with the USB Type-C cable, push and hold the middle push button, then power on NanoVNA-F V2. The device will be recognized as a U disk drive, and the following prompt information will appear on the device screen.

Firmware upgrade:

1. Connect the device to PC with Type-C cable;
2. The device will be recognized as a U-Disk;
3. Copy 'update.bin' into the U-Disk;
4. Power off and on;

According to the prompt information, the file 'update.bin' is required, which can be downloaded from our official website: www.sysjoint.com/nanovna-f_v2.html

Download the firmware file and unzip it to get 'update.bin'.

Copy 'update.bin' into the U-Disk, it may takes 10-15 seconds.

Power off and on the device, the firmware upgrade will complete automatically.
 When the firmware upgrade complete, the device will restart automatically, you can check the firmware version when the device startup.

8. Hardware architecture

